

eduard  
MASK

# Su-7 1/48

The die-cut mask for accurate canopy frame painting of the  
*Kopro 1/48 KIT*

## EX 083

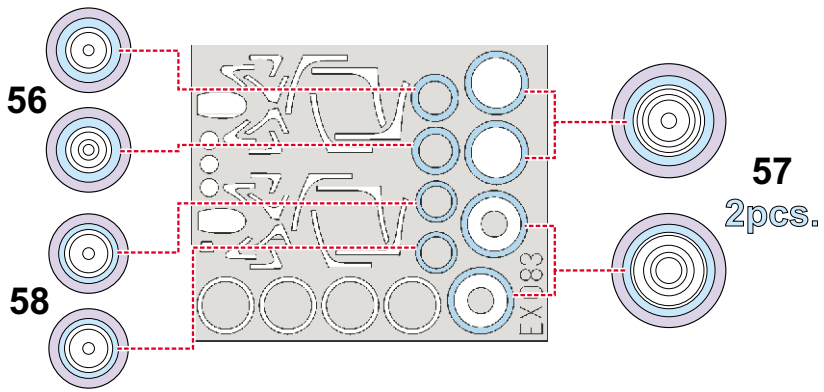
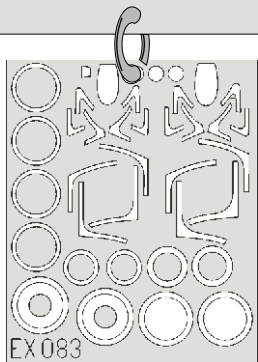

 - LIQUID MASK

115  
3 pcs.

113

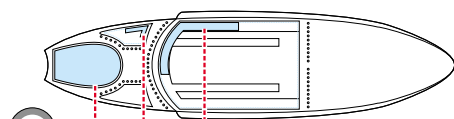
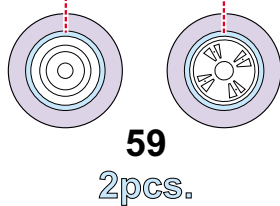
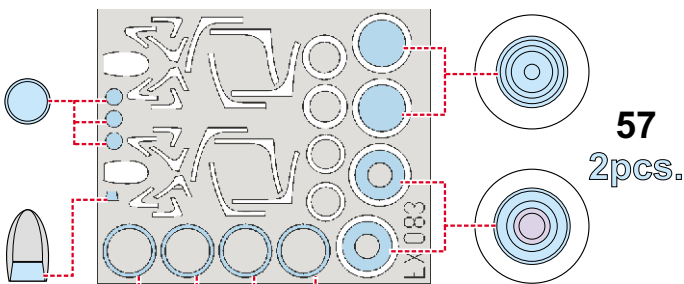

1.)

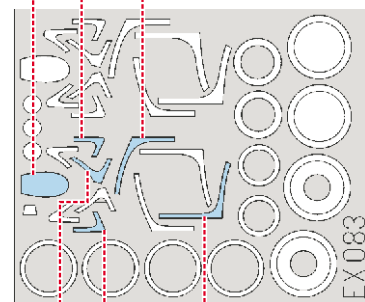

2.)

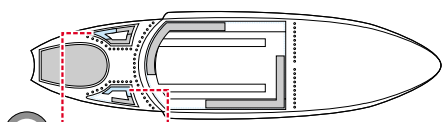
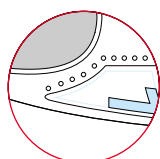

3.)

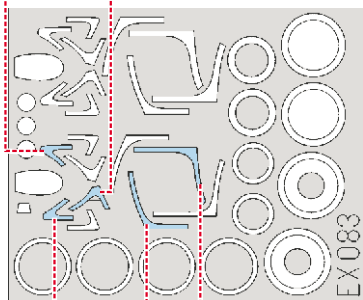

4.)

5.)



INTERIOR  
COLOR

6.)



RUBBER  
COLOR



LIQUID MASK

7.)

REMOVE  
MASK

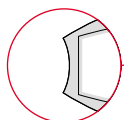

112

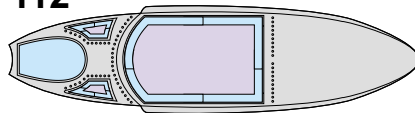

?

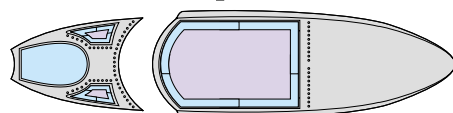

110

111

112

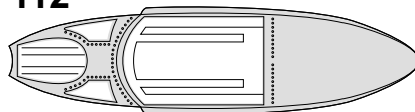

?

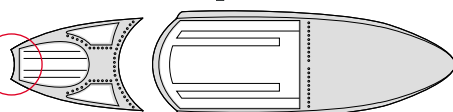

110

111

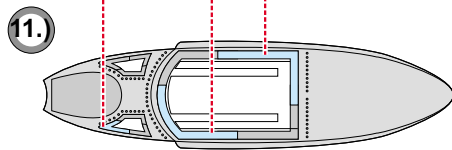
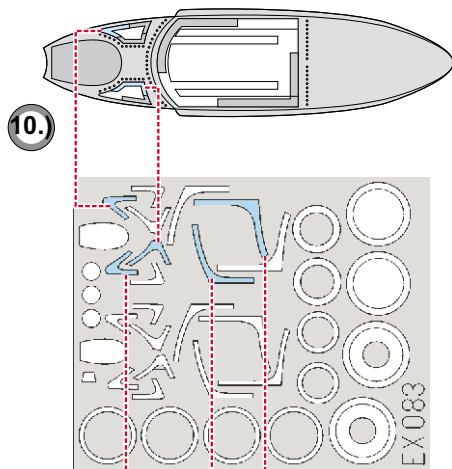
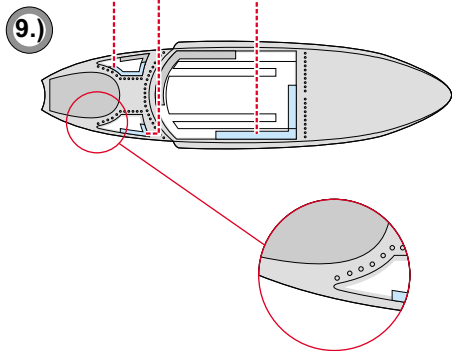
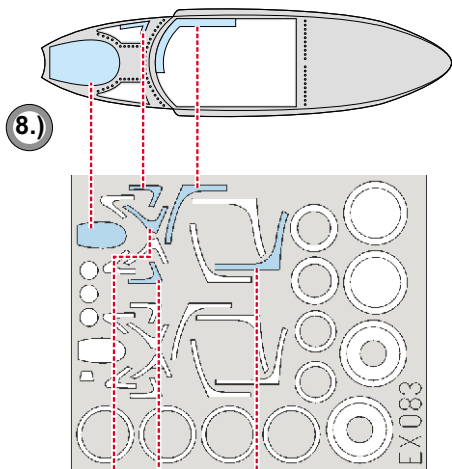

■ - LIQUID MASK

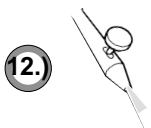

CAMOUFLAGE COLOR

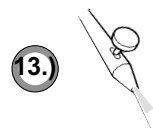

REMOVE MASK

110

111

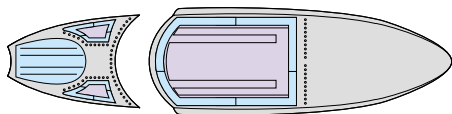

?

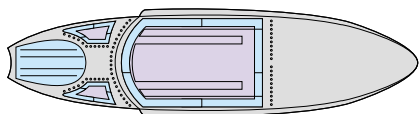

112

110

111

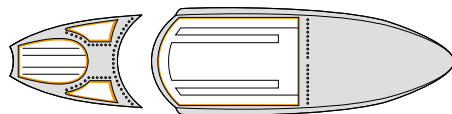

?

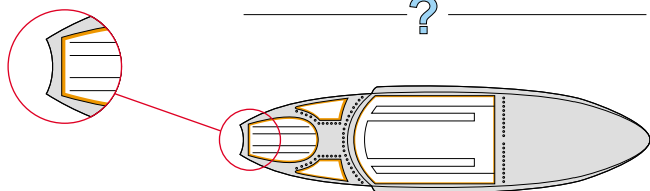

112