

648 794 F4F-3 landing flaps

for Eduard kit - pro stavebnici Eduard

eduard
BRASSIN
Print

1/48 scale

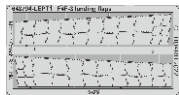
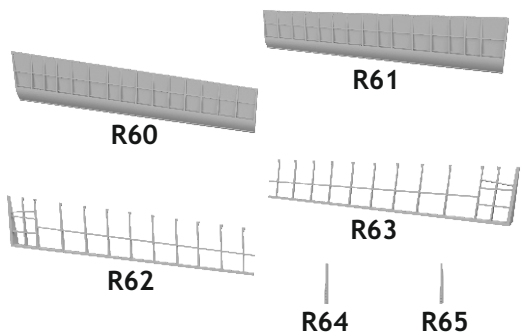

COLOURS

GSI Creos (GUNZE)		Mr.METAL COLOR	
AQUEOUS	Mr.COLOR	Mr.METAL COLOR	
[H 58]	[C351]	INTERIOR GREEN	
[H325]	[C325]	GRAY	

This product contains metal and resin detail parts for upgrading scale plastic models. When selecting this set make sure that it is for the kit mentioned in product name as these sets are made specifically for that kit. When upgrading the model some cutting or corrections may be necessary for parts to fit accurately. **WARNING!** This set contains small and sharp parts. Work carefully in a ventilated and well-lit room. Safety glasses are recommended. This product is not suitable for children below 14 years of age.

Tento výrobek obsahuje leptané a odlévané detaily pro úpravu a vylepšení plastického modelu. Při výběru sady kovových detailů zkontrolujte, zda je určena pro model, který chcete upravit. Model, pro který je sada určena, je uveden u názvu výrobku. Pro přesnou aplikaci kovových a odlévaných dílů může být zapotřebí upravit díly upravovaného modelu. **POZOR!** Sada obsahuje malé ostré díly. Pracujte ve větrané a dobře osvětlené místnosti. Doporučujeme použití ochranných brýlí. Tento výrobek není vhodný pro děti mladší 14 let.

eduard

www.eduard.com

19,95

435 21 Obrnice 170
Czech Republic



648 794

F4F-3 landing flaps

for Eduard kit - pro stavebnici Eduard

1/48

BRASSIN

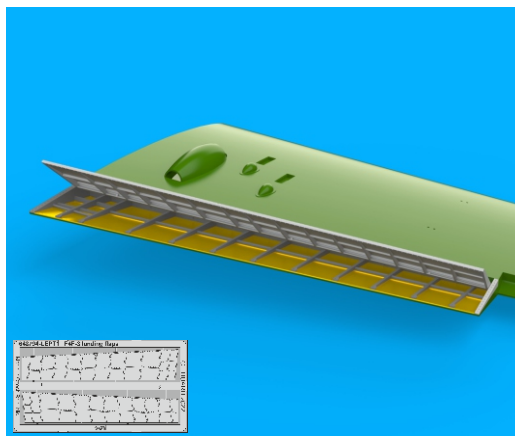

BRASSIN

eduard

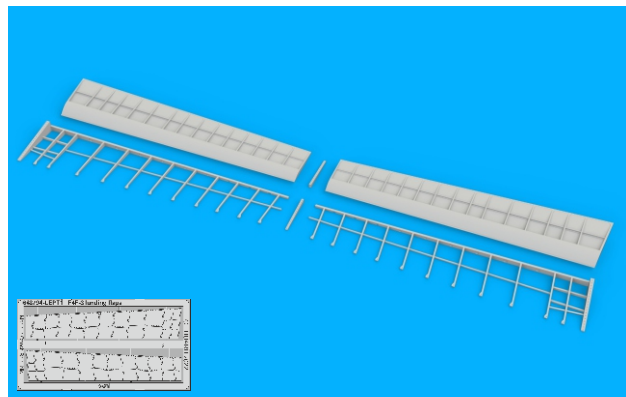

BEST BRASS RESIN AROUND!



plastic
E3  E1

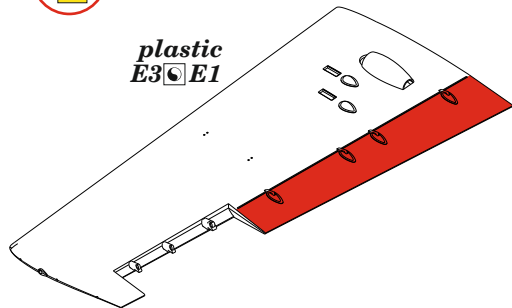

plastic
E4  E2

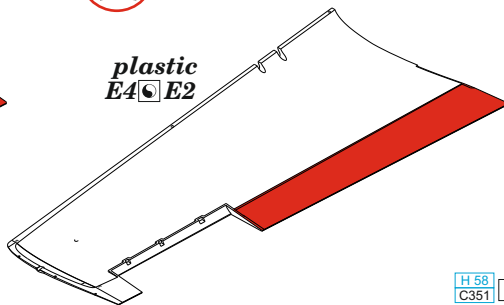

H 58
C351
INTERIOR
GREEN

H325
C325
GRAY

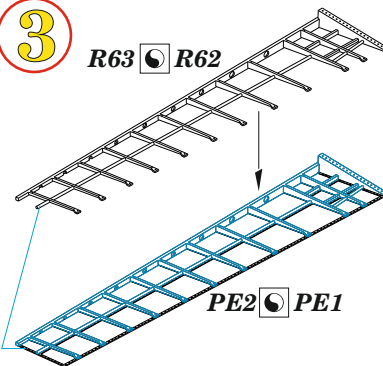

PE2  PE1

4

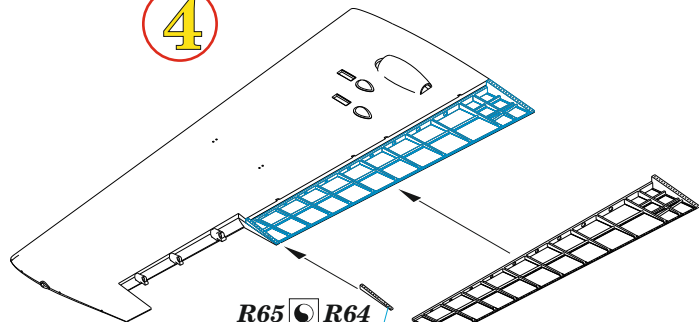

R65  R64

UNDERSURFACE COLOR







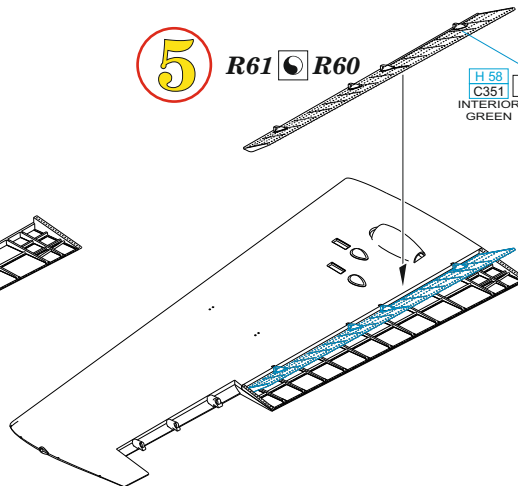

5

R61  R60

H 58
C351
INTERIOR
GREEN

H325
C325
GRAY



- | | | | |
|---|---|---|---------------------|
|  | REMOVE
ODSTRANIT |  | BEND
OHNOUT |
|  | GRIND
OBROUSIT |  | OPTION
VOLBA |
|  | DRILL HOLE
VRTAT OTVOR |  | REPLACE
NAHRADIT |
|  | SYMMETRICAL ASSEMBLY
SYMETRICKÁ MONTÁŽ | | |
|  | SCRIBE THE PANEL AND HOLES
RYTI | | |
|  | REVERSE SIDE
OTOČIT | | |