







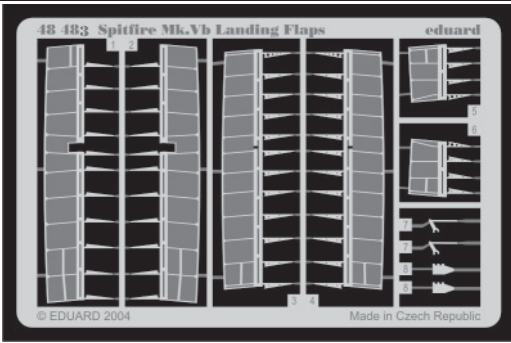

# Spitfire Mk.Vb Landing Flaps

eduard

48 483

1/48 scale detail set for TAMIYA kit • sada detailů pro model TAMIYA 1/48



-  SYMMETRICAL ASSEMBLY  
SYMETRICKÁ MONTÁŽ
-  REMOVE  
ODSTRANIT
-  BEND  
OHNOUT
-  REPLACE  
NAHRADIT
-  GRIND  
OBROUSIT
-  OPTION  
VOLBA

 ORIGINAL KIT PARTS  
PŮVODNÍ DÍLY STAVEBNICE

 PHOTO-ETCHED PARTS  
LEPTANÉ DÍLY

 PARTS TO BE REMOVED  
DÍLY K ODSTRANĚNÍ

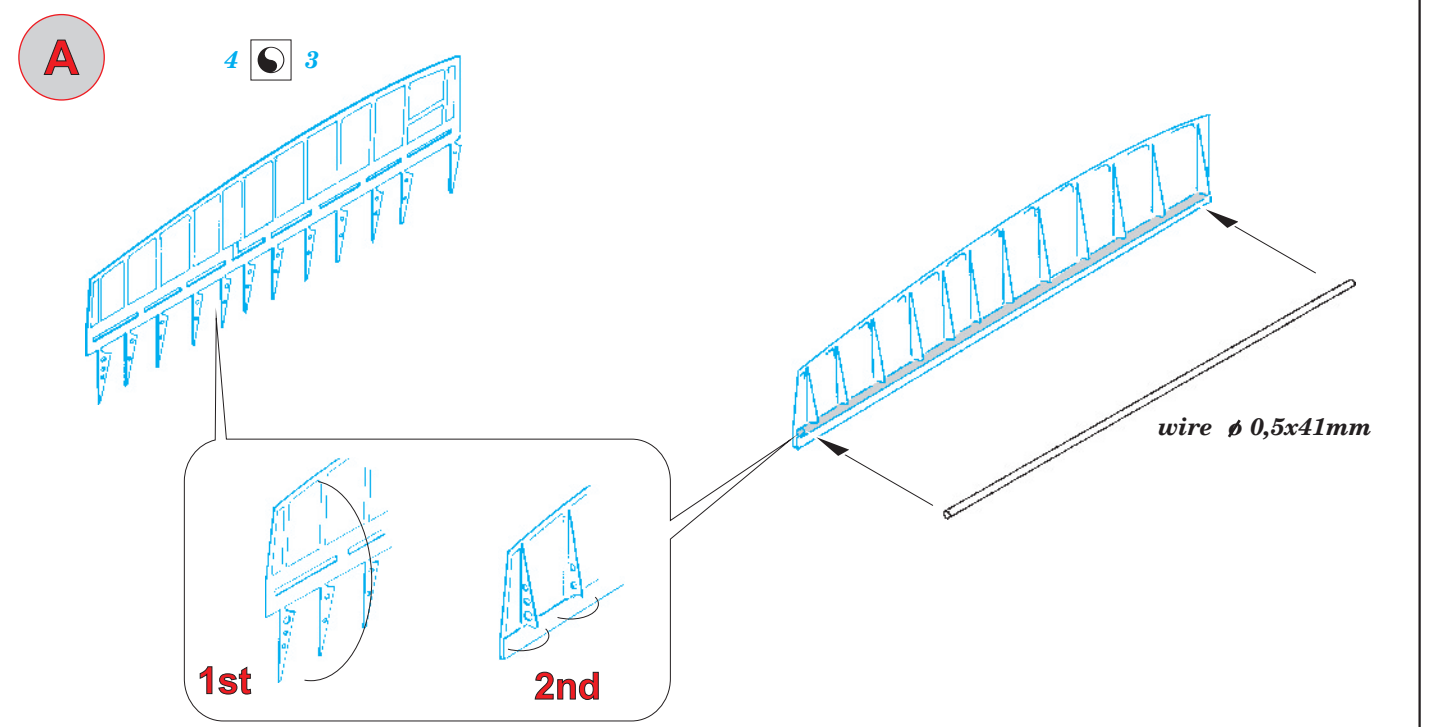
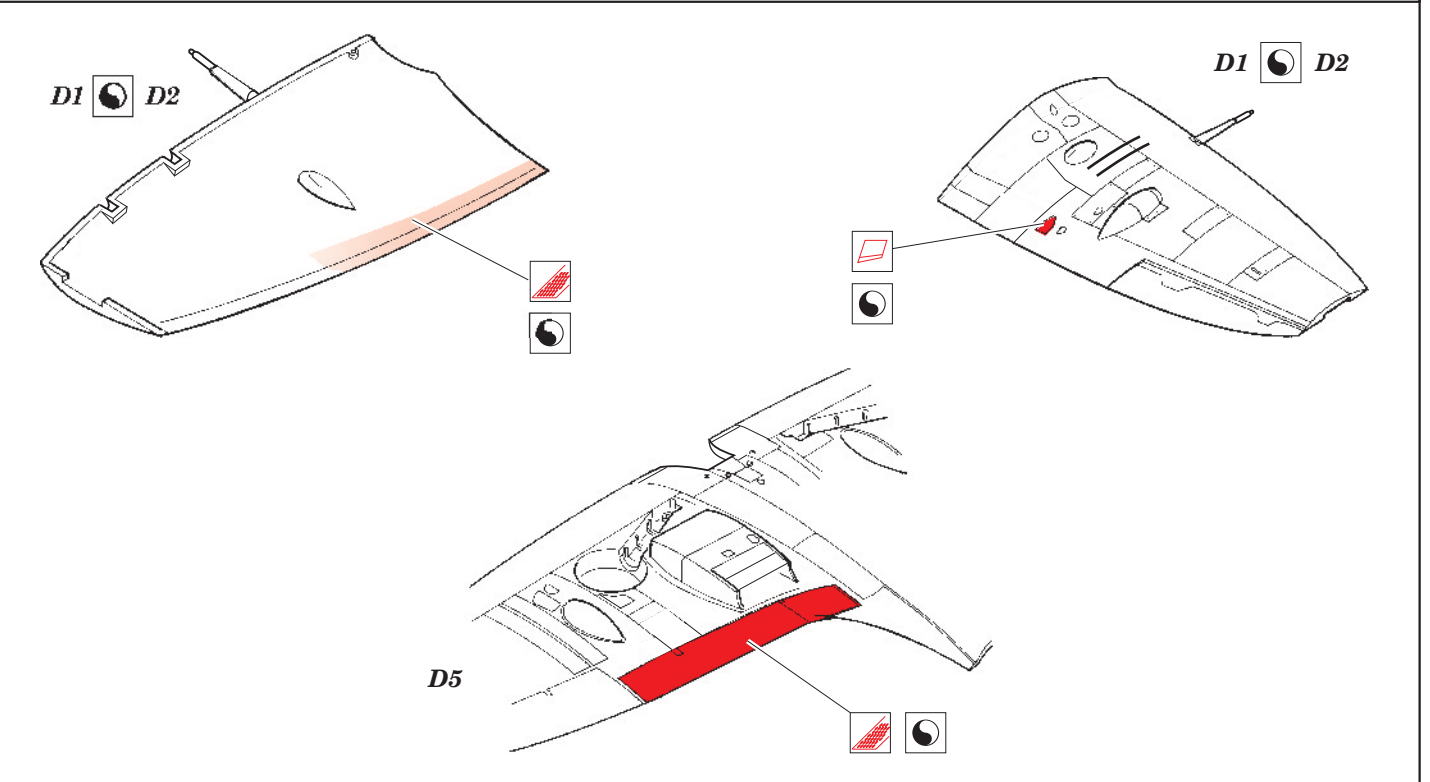

**B**

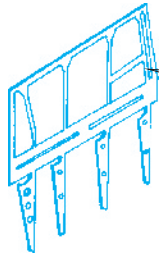

6 5

**1st**



**2nd**

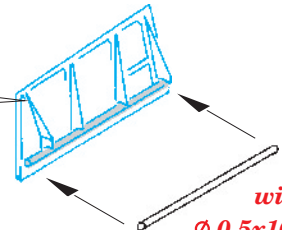

wire  
Ø 0,5x10,0mm

**C**

**1st**

1 2

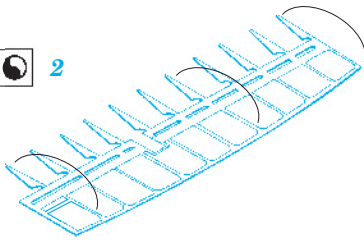

**2nd**

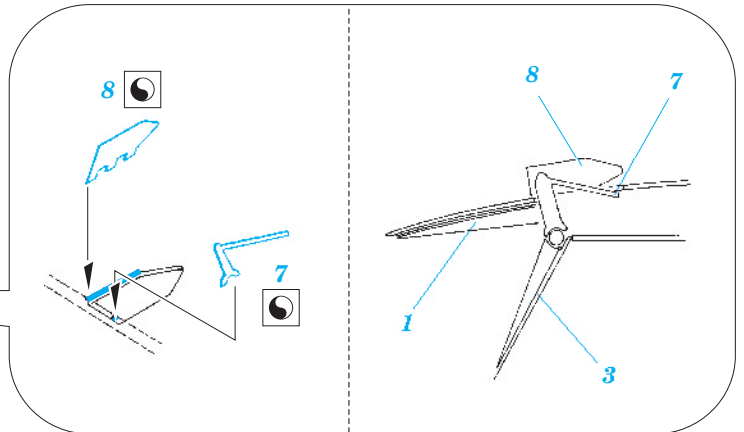
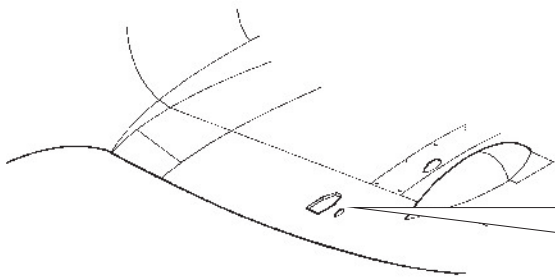
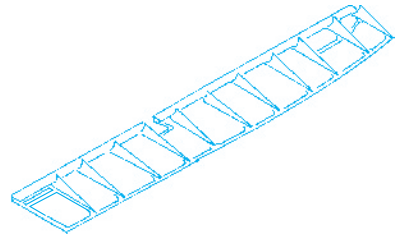

**A**

**B**

**C**

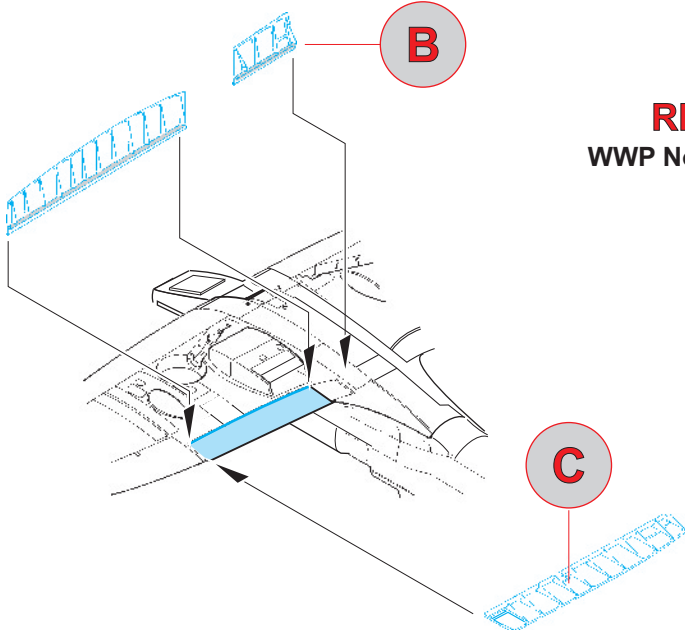

**REFERENCES:**  
WWP No 26 Spitfire in Detail