

eduard
MASK

F-14D Tomcat

The die-cut mask for accurate canopy frame painting of the
Hasegawa 1/48 KIT

EX 037

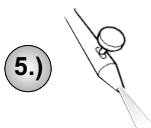
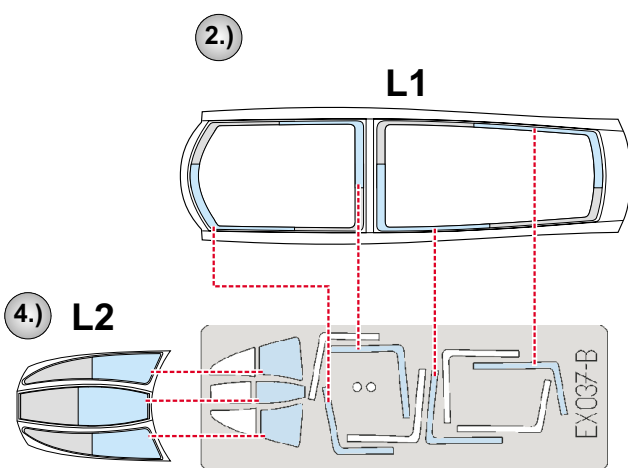
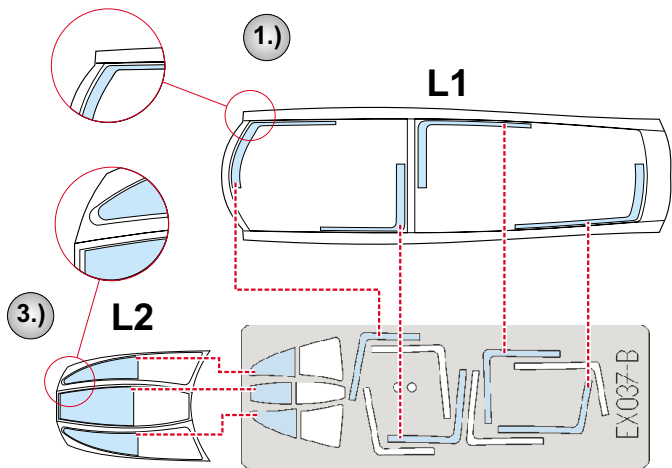
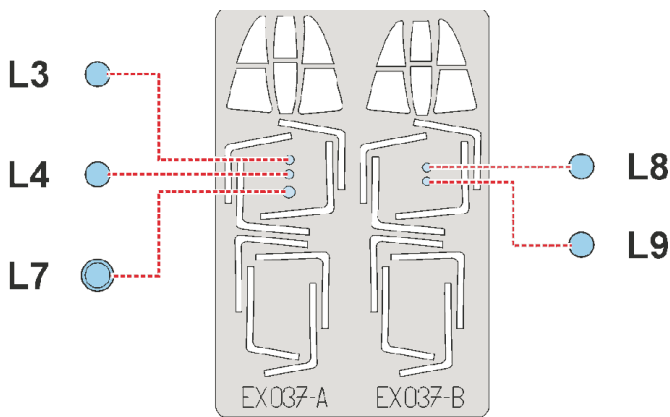
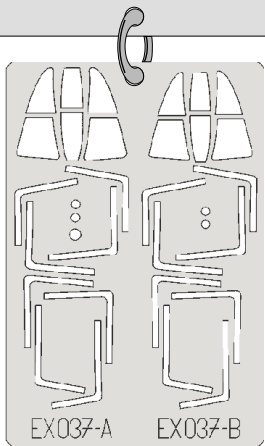

5.) INTERIOR COLOR

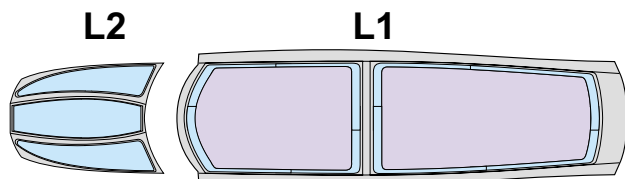

LIQUID MASK ■

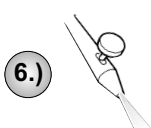

6.) RUBBER COLOR

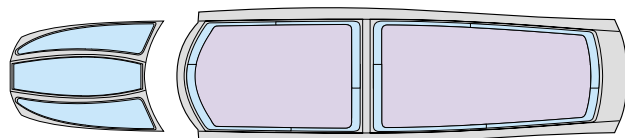

7.) REMOVE MASK

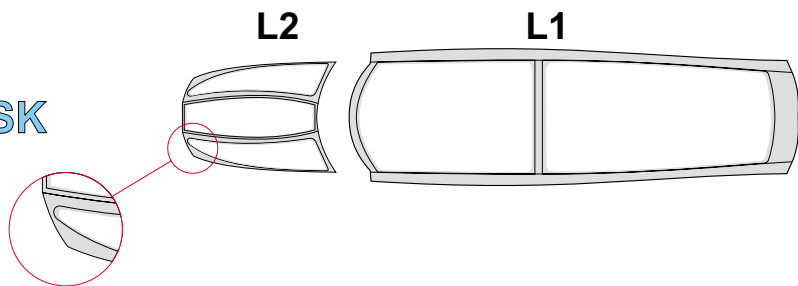

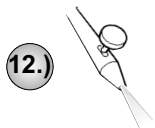
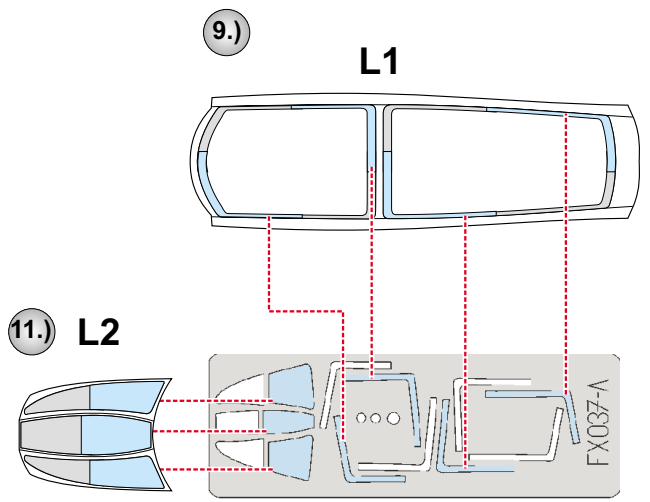
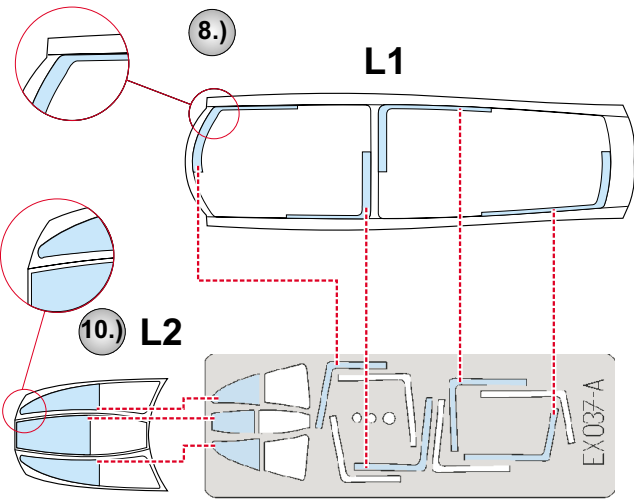

12.) CAMOUFLAGE
COLOR

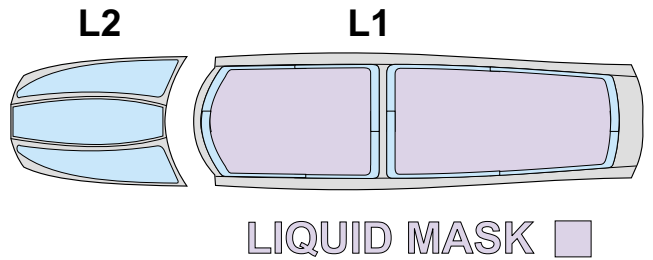

13.) REMOVE MASK

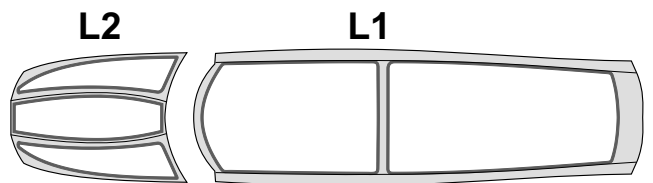

REFERENCES: Squadron/Signal Publ.:Walk Around # 3 - F-14 Tomcat
Squadron/Signal Publ.:In Action # 105 - F-14 Tomcat