

eduard
MASK

Fw 190A (new tool)

The die-cut mask for accurate canopy frame painting of the
Hasegawa 1/32 KIT

JX 010

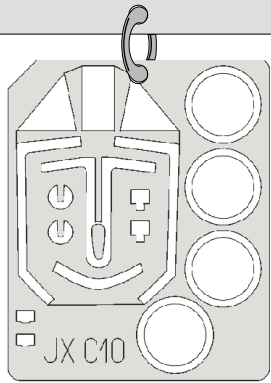

LIQUID MASK ■ 2pcs

F20

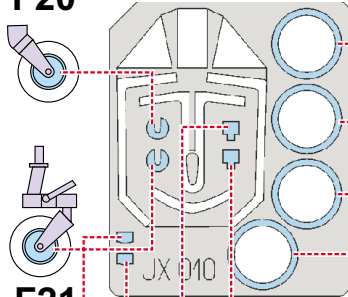

F21

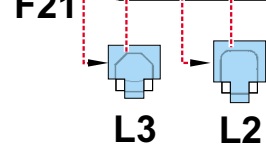

L3

L2

2pcs
K31

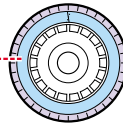

2pcs
K26

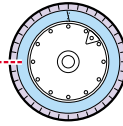

2pcs
K31

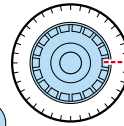

2pcs
K26

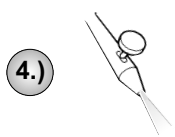
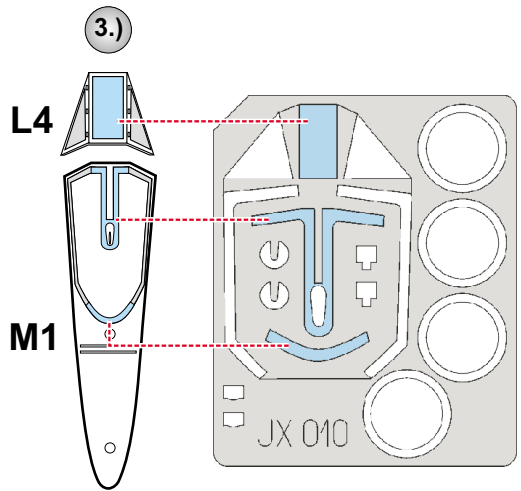
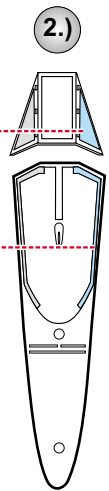
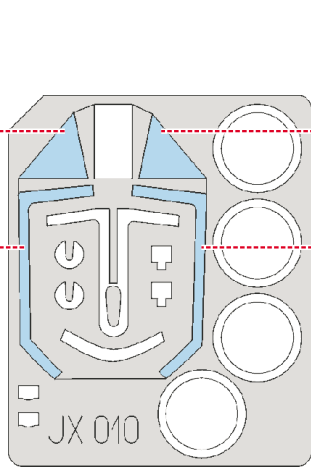
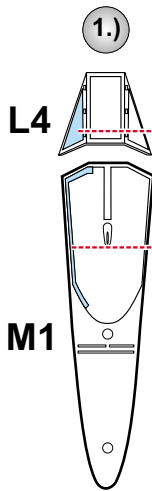
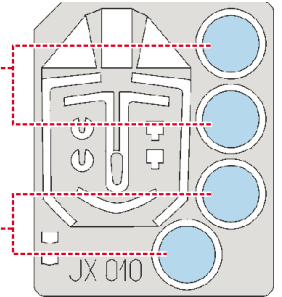
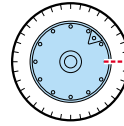

4.) INTERIOR COLOR

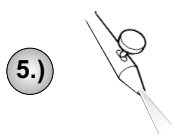
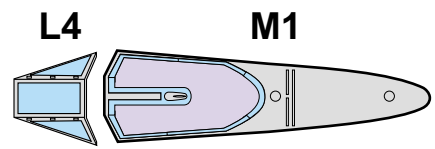

5.) CAMOUFLAGE COLOR

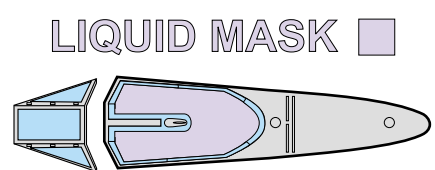

6.) REMOVE MASK

